

HM 3080

Dimensions

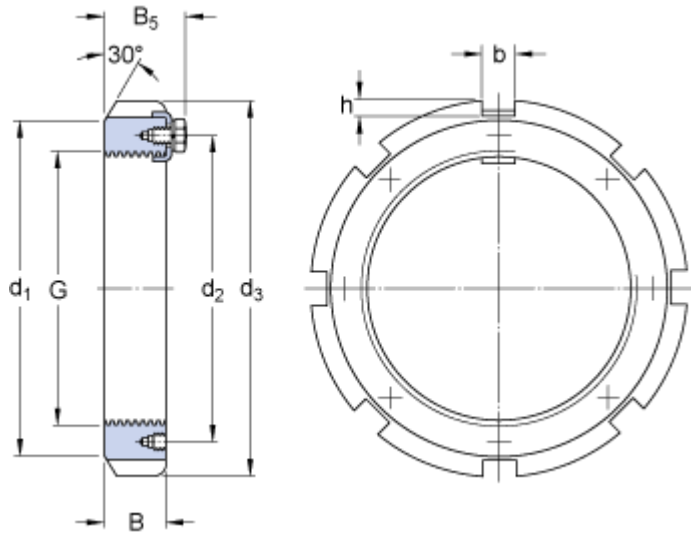

G	Tr 400x5	
d ₃	470	mm
B	52	mm
d ₁	442	mm
d ₂	419	mm
B ₅	66	mm
b	28	mm
h	14	mm

Mass

Mass lock nut	17	kg
---------------	----	----

Mounting information

Appropriate spanner	TMFN 64-80
---------------------	------------

Appropriate products

Locking clip	MS 3080-76
--------------	------------